

IQ/485[®] Network Interface

Integration of Shades, Controls, and Accessories

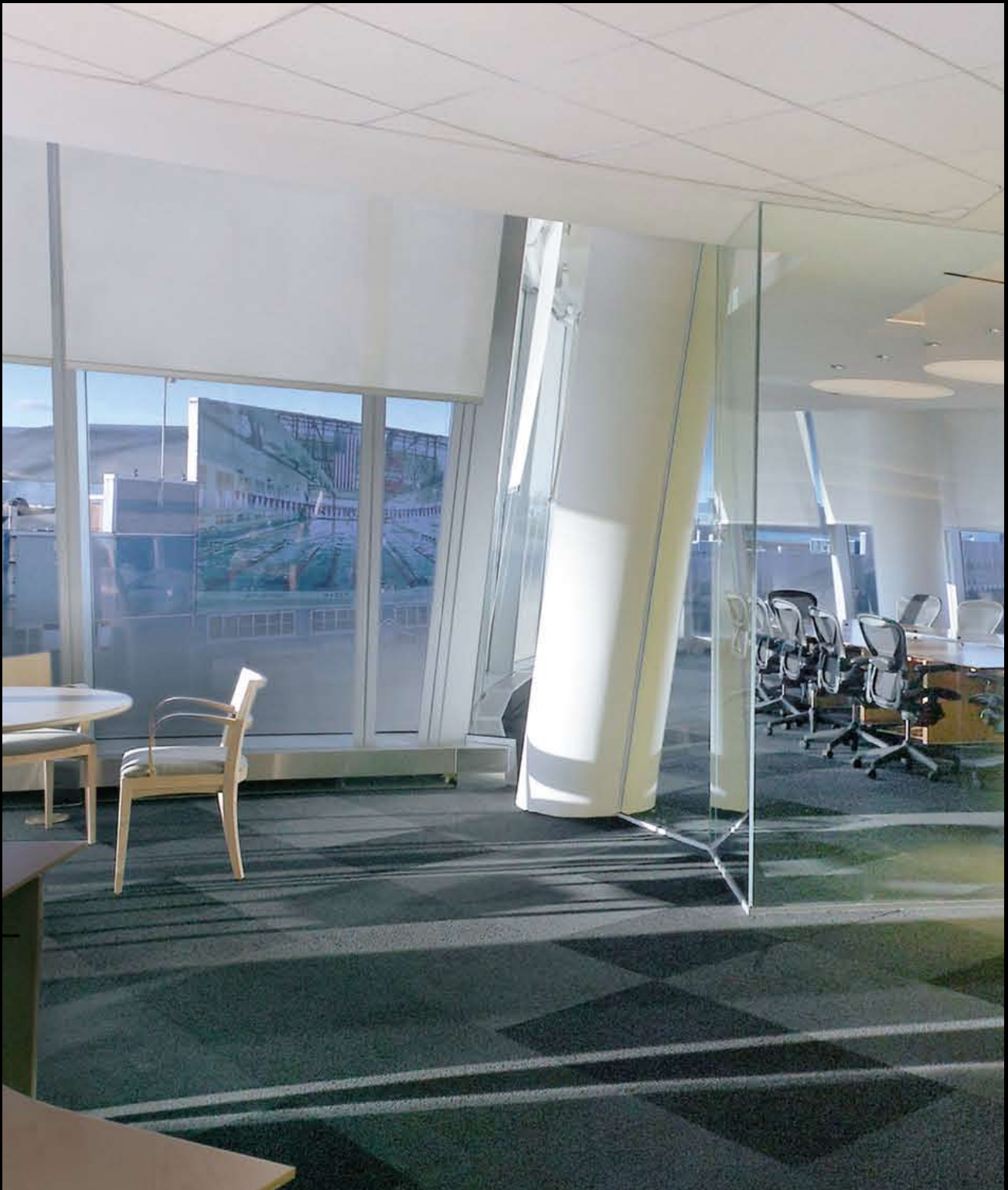

IQ/485[®] Network Interface

The new IQ/485 Network integrates various window-covering devices with a variety of switches, accessories, or 3rd-party control systems. It also provides a hub that enables inputs for RS232-based systems, dry-contact devices, and various accessories.

In addition, there are outputs that control momentary dry-contact devices including ElectroShades[®] and WhisperTrac[®] motors.

The bus connections extend control throughout the IQ/485 Network to other IQ/485 network accessories and IQ/485 equipped controllers.

A

Five dry-contact output ports

WindowManagement[®] controls

- Control of momentary dry-contact window-treatment motors or accessories via the IQ/485 NI including WhisperTrac[®] draperies and motorized ElectroShades[®] (IQ/MLC[®]s and intelligent motors)
- Support of multi-level controls (independent, group, master, etc.) without the complexity of hardwiring through the IQ/485 software-control addresses.
- Eight addresses for each of the five input and output ports.
- Daisy chains up to two IQ/MLC[®]s for each output port.
- Each output port supports the positioning of window coverings with up to five alignment points using the IQ/MLC[®] control logic.

Figure 1. Intermediate alignment points

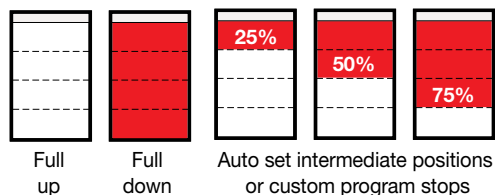

B

Three automation and remote control ports

Multi-zone window control

- Integration of the entire shading system through the RS232 protocol for a single point of control to a 3rd-party control system.
- IR port to promote wireless IR remote control.
- Automation of the shade control via photo-sensors, schedulers/timers, remote control via RF (RTS) through the accessories port.
- RS232 port provides two-way communication for shade control along with feedback of the shade position and its status.

C

IQ/485[®] bus ports

Robust communication network

- Reliable two-way communication over the IQ/485 Network.
- Capable of over 65,000 control addresses from a single network.
- Bus 1 also provides DC power for various IQ/485 bus accessories like IR eye and IQ/485 six-group keypad.
- Directly compatible with other IQ/485 products such as the IQ/485 SMC, and the six-group keypad.

D

Five dry-contact input ports

Switch controller

- Economical shade control through dry-contact control.
- Compatible with IQ/MLC[®] switches
 - Operates shades up to five alignment points (See Figure 1).
- Compatible with a variety of accessories, including RTS wireless control, various timer/scheduler controls, and others.
- Seamless integration with 3rd-party control systems, including Crestron[®], Vantage/Legrand[®], Lutron[®], and other systems via contact closures.
- Programmable options for momentary and maintained inputs.
- Compatible with 3rd-party systems utilizing single-button operation of window treatments.
- Ability to control any motor connected to the IQ/485 NI through any input port.

IQ/485[®] Network Interface

A

Five dry-contact output ports



IQ/MLC[®]

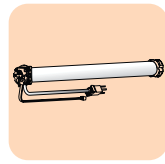

Includes intelligent motors

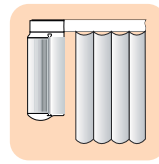

WhisperTrac[®]



RTS transmitter

B

Three accessory and central-control input ports

C

IQ/485[®] bus ports

IQ/485[®] MC (Single-Motor Controller)

IQ/485[®] MC (Single-Motor Controller)

IQ/485[®] Six-group keypad

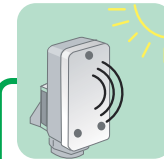
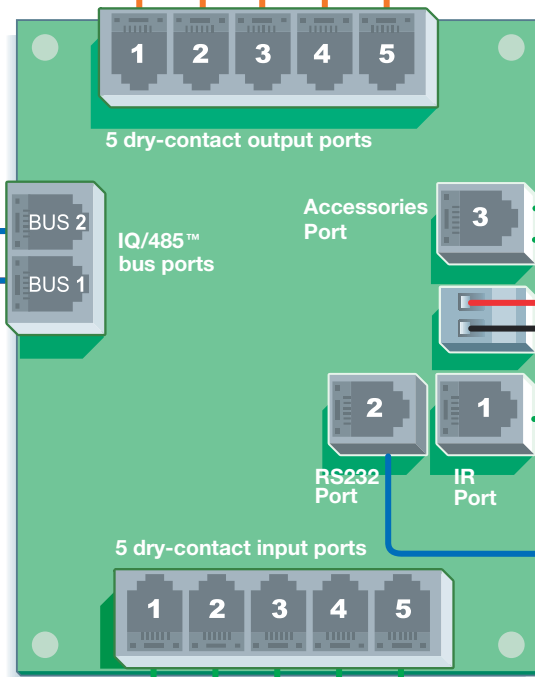

SAC (Sun-Activated™ Controller)



RTS receiver



IR receiver port

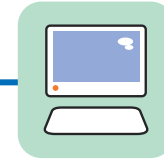

RS232 (two-way communication) PC, touchscreen

D

5 dry-contact input ports



IQ/MLC[®] switch



Decorator paddle switch



A/V system



Lighting-dimming system

IQ/485® Control System Network

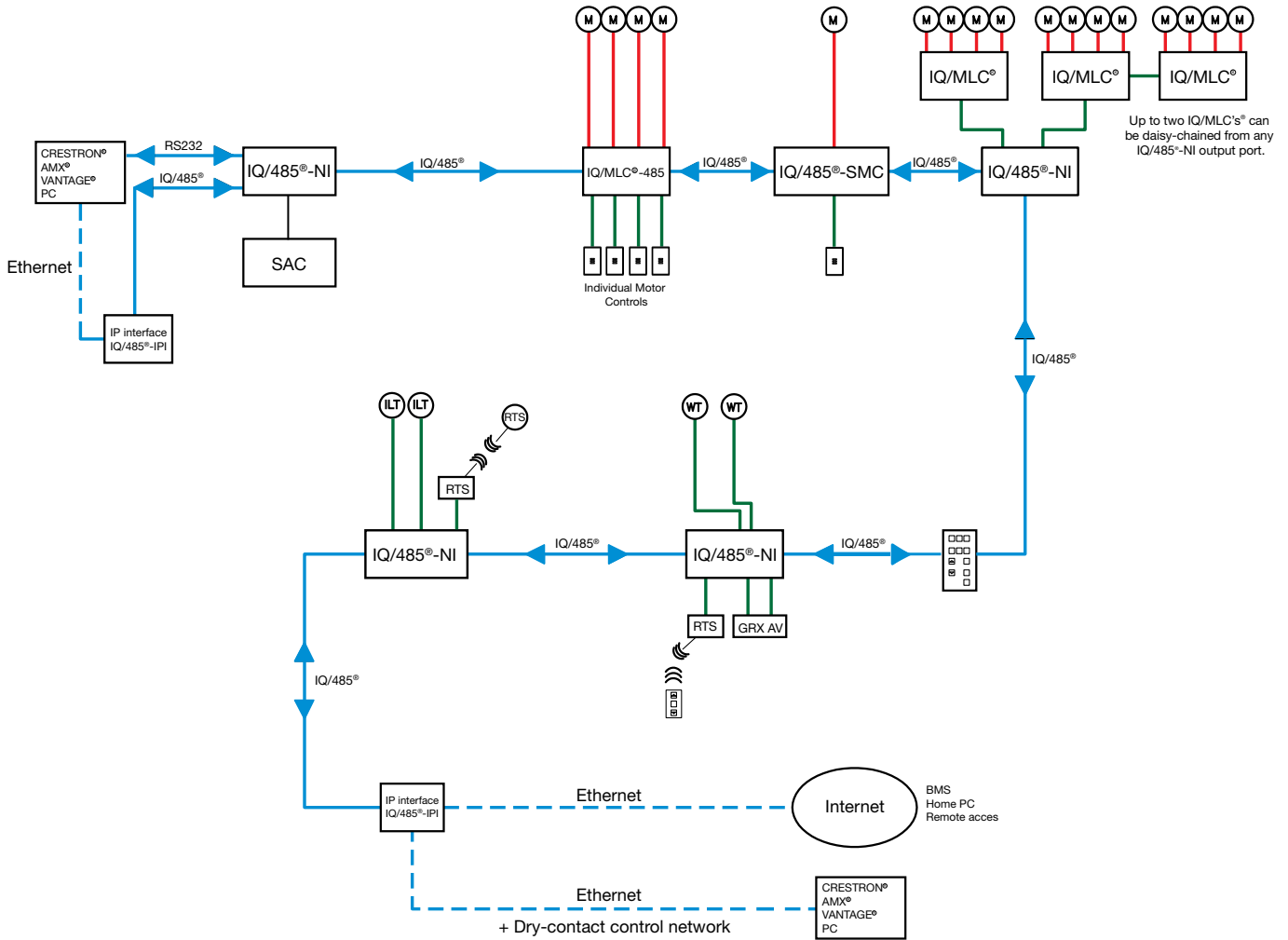

Key:

- Low voltage dry contact
- IQ/485™ Network
- Line voltage (120v)
- RTS Somfy® radio motor
- RTS Somfy® radio transmitter
- ILT Somfy® encoded motor
- WT WhisperTrac™ motor
- M Motor



MechoSystems
 Corporate Headquarters
 42-03 35th Street
 Long Island City, NY 11101
 T : +1 (718) 729-2020
 F : +1 (718) 729-2941
 W: mechosystems.com
 marketing@mechosystems.com

Copyright © 2011 MechoShade Systems, Inc. All rights reserved. All trademarks herein are owned by MechoShade Systems, Inc. No part of this document may be reproduced or otherwise used without the express written consent of MechoShade Systems, Inc. This literature was printed on post-consumer paper with soy-based ink.



L10001.0611